



Catálogo Digital





JUST



# Uma gama completa de soluções

Pensada para resolver de forma simples e versátil diferentes necessidades, a Just foi desenhada reunindo soluções técnicas inteligentes, com design funcional dedicado à melhor experiência dos seus usuários.

## Modalidades de Atendimento



### PRODUTO DE LINHA

Produtos e acabamentos de catálogo com lead time reduzido.



### PRODUTO CONFIGURADO

Produtos de linha com medidas especiais, ajustadas ao projeto.



Plataformas  
04

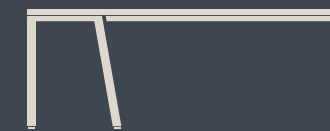

Individuais  
08

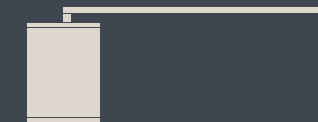

Gerenciais  
10

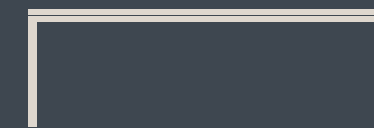

Reunião  
12

## Plataformas

Planos de trabalho moduláveis e dinâmicos para equipes.



# Just. A estação de trabalho para quem é especialista.

Uma linha completa de soluções, flexível como a dinâmica do trabalho contemporâneo.



1 - Tampo único (sem emendas) para estações duplas.

2 - Acesso fácil e descentralizado para tomadas.

3 - Calha leito profunda para acomodação perfeita de cabos e fontes.

4 - Pé shaft com tamanho ideal para subida e acomodação de cabos.

5 - Fixação fácil de painéis divisores pela parte superior do tampo.

## Pés Laterais

A identidade da linha pode ser facilmente customizada a partir das 5 opções de bases disponíveis.

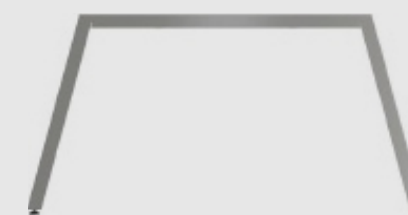

Pés em ângulo (Cavalete)

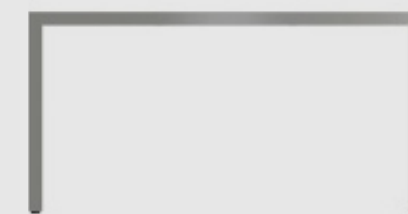

Pés em formato trave

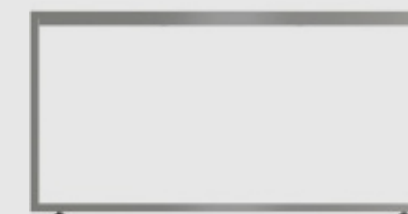

Pés em formato requadro

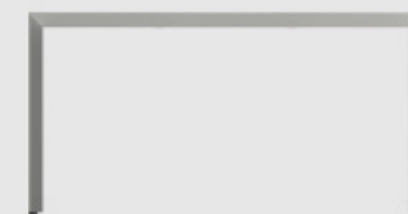

Pés em formato trave com perfil triangular

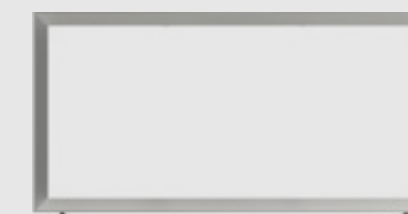

Pés em formato requadro com perfil triangular

## Pés Centrais

Estrutura centrais com ou sem shaft, se adequando ao volume de cabos e ao orçamento de cada projeto.



Com Shaft



Sem Shaft

# Plataforma Dupla (Frente e Verso)

## 1 - Tapos

**Estrutura Lateral (EL)**  
Recebe pé de um lado.

**Estrutura Central (EC)**  
Recebe pé shaft dos dois lados.

**Estrutura Mista (EM)**  
Recebe pé shaft e pé lateral.

**Estrutura Dupla (ED)**  
Recebe pé lateral dos dois lados.

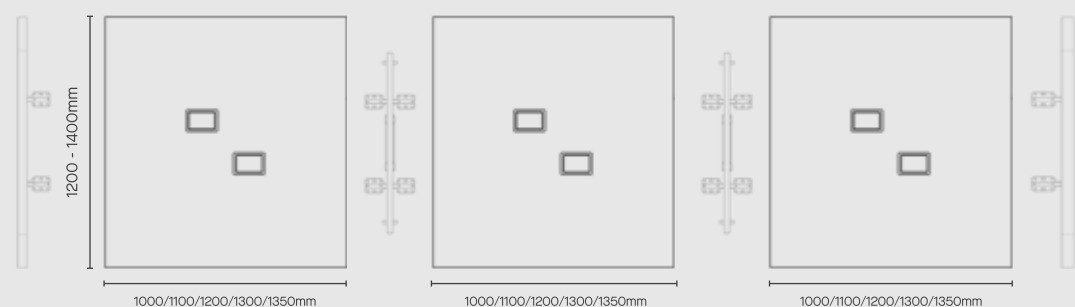

CÓDIGOS	1200mm	1400mm	CÓDIGOS	1200mm	1400mm	CÓDIGOS	1200mm	1400mm
1000mm	JT1012EL	JT1014EL	1000mm	JT1012EC	JT1014EC	1000mm	JT1012EM	JT1014EM
1100mm	JT1112EL	JT1114EL	1100mm	JT1112EC	JT1114EC	1100mm	JT1112EM	JT1114EM
1200mm	JT1212EL	JT1214EL	1200mm	JT1212EC	JT1214EC	1200mm	JT1212EM	JT1214EM
1300mm	JT1312EL	JT1314EL	1300mm	JT1312EC	JT1314EC	1300mm	JT1312EM	JT1314EM
1350mm	JT13512EL	JT13514EL	1350mm	JT13512EC	JT13514EC	1350mm	JT13512EM	JT13514EM

CÓDIGOS	1200mm	1400mm
1000mm	JT1012ED	JT1014ED
1100mm	JT1112ED	JT1114ED
1200mm	JT1212ED	JT1214ED
1300mm	JT1312ED	JT1314ED
1350mm	JT13512ED	JT13514ED

## 2 - Bases

**Pés em formato trave 50x50**  
JT1200 / JT1400



**Pés em ângulo (Cavalete) 50x50**  
JT1200A / JT1400A

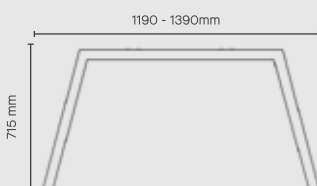

**Pés em formato trave com perfil triangular 50x50**  
JT1200T / JT1400T



**Pés em formato requadro com perfil triangular 50x50**  
JT1200RT / JT1400RT



**Pés em formato requadro 50x30**  
JT1200R / JT1400R



## 3 - Estrutura Central

**Estrutura central com Shaft**  
ECJ1200CS / ECJ1400CS

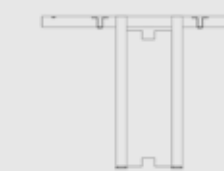

**Estrutura central sem Shaft**  
ESTC1200C / ESTC1400C



## Montagem

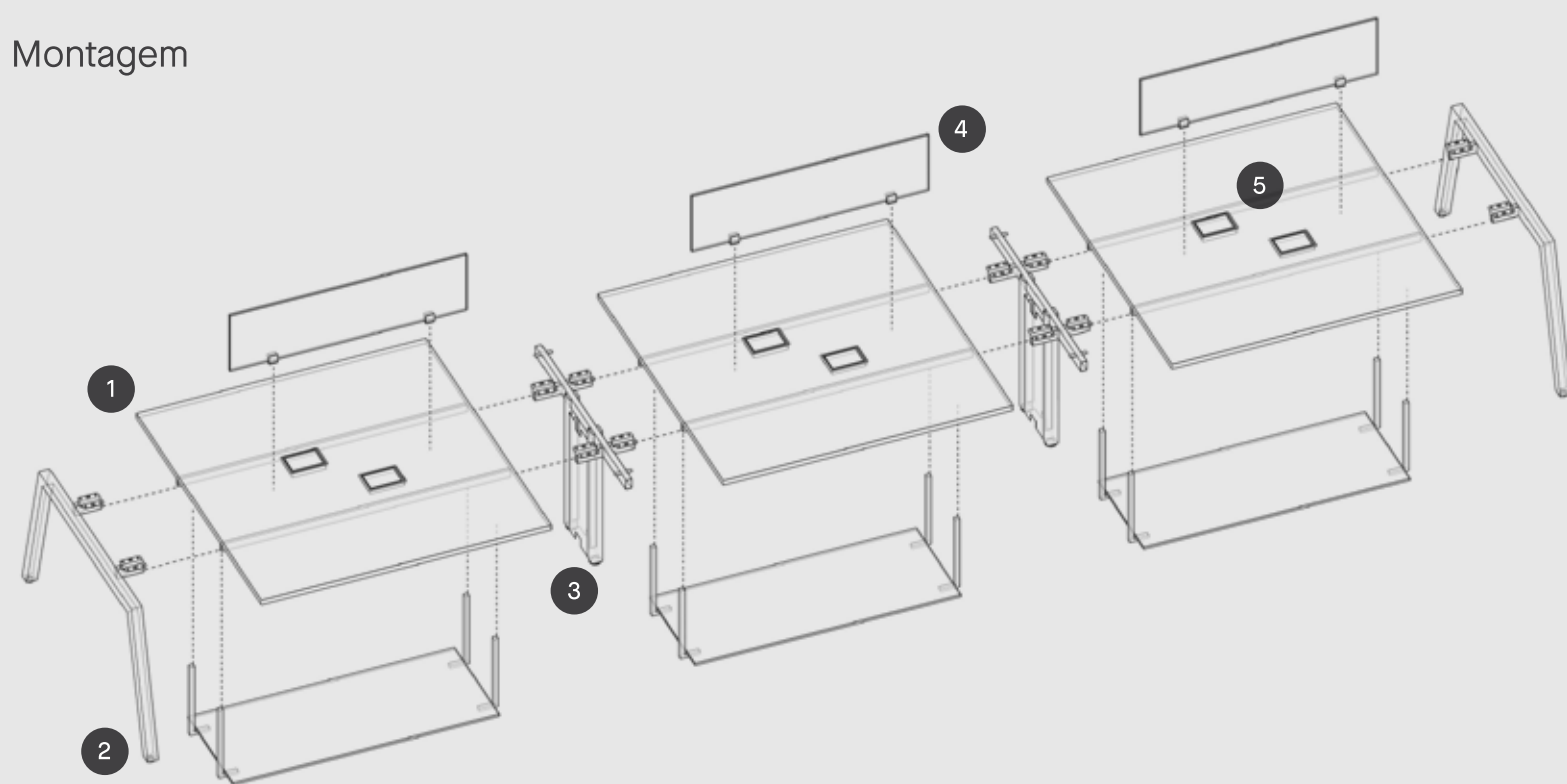

## 4 - Acessórios

**Painel Divisor MDP**

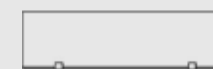

Painel divisor suspenso em MDP 15 mm para plataforma.

JTPNDV100  
JTPNDV110  
JTPNDV120  
JTPNDV130  
JTPNDV135

**Painel Divisor Vidro**

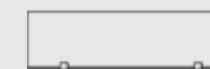

Painel divisor suspenso em vidro 8 mm transparente, jateado ou revestido em película colorida para plataforma.

JTPNV110  
JTPNV110  
JTPNV120  
JTPNV130  
JTPNV135

**Suporte para CPU**  
1200mm



Suporte CPU estação dupla de profundidade 1200

SUPB1012  
SUPB1112  
SUPB1212  
SUPB1312  
SUPB13512

**Suporte para CPU**  
1400mm



Suporte CPU estação dupla de profundidade 1400

SUPB1014  
SUPB1114  
SUPB1214  
SUPB1314  
SUPB13514

## 5 - Eletrificação



Conexão completa em cada posto de trabalho: Tomadas posicionadas para melhor acomodação de carregadores e conexão de dados completa. Plugs não inclusos.



Facilidade para eletrificação e manutenção: O sistema de calha com ganchos facilita o trabalho de manutenção.

# Plataforma Simples (Lado a Lado)

## 1 - Tampo

**Estrutura Lateral (EL)**  
Recebe pé de um lado.

**Estrutura Central (EC)**  
Recebe pé shaft dos dois lados.

**Estrutura Mista (EM)**  
Recebe pé shaft e lateral.



CÓDIGOS	600mm	700mm
1000mm	JT1006EL	JT1007EL
1100mm	JT1106EL	JT1107EL
1200mm	JT1206EL	JT1207EL
1300mm	JT1306EL	JT1307EL
1350mm	JT13506EL	JT13507EL

CÓDIGOS	600mm	700mm
1000mm	JT1006EC	JT1007EC
1100mm	JT1106EC	JT1107EC
1200mm	JT1206EC	JT1207EC
1300mm	JT1306EC	JT1307EC
1350mm	JT13506EC	JT13507EC

CÓDIGOS	600mm	700mm
1000mm	JT1006EM	JT1007EM
1100mm	JT1106EM	JT1107EM
1200mm	JT1206EM	JT1207EM
1300mm	JT1306EM	JT1307EM
1350mm	JT13506EM	JT13507EM

**Estrutura Dupla (ED)**  
Recebe pé lateral dos dois lados.

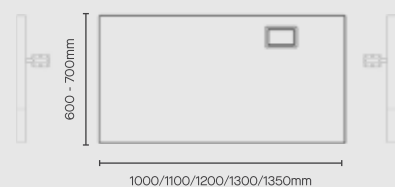

CÓDIGOS	600mm	700mm
1000mm	JT1006ED	JT1007ED
1100mm	JT1106ED	JT1107ED
1200mm	JT1206ED	JT1207ED
1300mm	JT1306ED	JT1307ED
1350mm	JT13506ED	JT13507ED

## 2 - Bases

**Pés em formato trave 50x50**

Direito - JT600D / JT700D  
Esquerdo - JT600E / JT700E

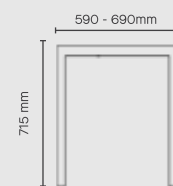

**Pés em ângulo (Cavalete) 50x50**

Direito - JT600AD / JT700AD  
Esquerdo - JT600AE / JT700AE

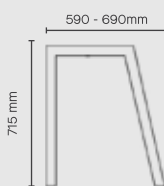

**Pés em formato trave com perfil triangular 50x50**

Direito - JT600TD / JT700TD  
Esquerdo - JT600TE / JT700TE

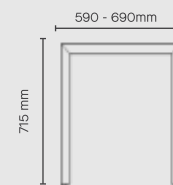

**Pés em formato requadro com perfil triangular 50x50**

Direito - JT600RTD / JT700RTD  
Esquerdo - JT600RTE / JT700RTE

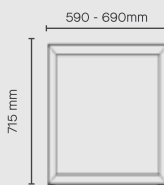

**Pés em formato requadro 50x30**

Direito - JT600RD / JT700RD  
Esquerdo - JT600RE / JT700RE

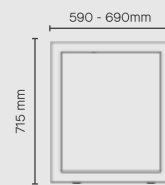

## 3 - Estrutura Central

**Estrutura central com Shaft**  
ECJ600CS / ECJ700CS

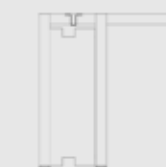

**Estrutura central sem Shaft**  
ECJ600C / ECJ700C

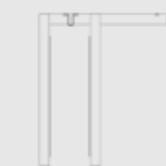

## Montagem

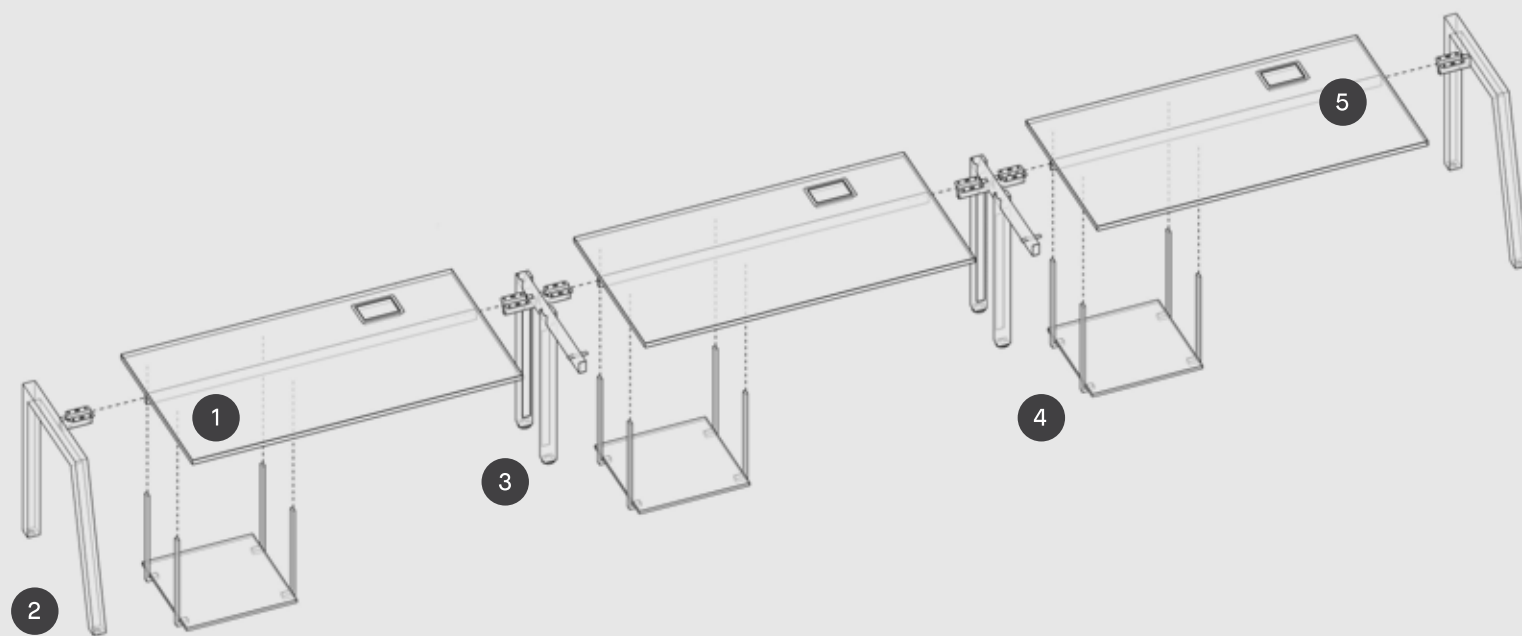

## 4 - Acessórios

**Suporte para CPU**  
Estação Simples



SUPB437

## 5 - Eletrificação



Conexão completa em cada posto de trabalho: Tomadas posicionadas para melhor acomodação de carregadores e conexão de dados completa. Plugs não inclusos.



Facilidade para eletrificação e manutenção: O sistema de calha com ganchos facilita o trabalho de manutenção.



## Individuais

Espaço de uso individual, retas ou em “L” com superfície de trabalho ampliada.





1 - Tapos

Tapos Mesa em L



CODIGOS	800mm
1600mm	MGJT160
1800mm	MGJT180
2000mm	MGJT200
2200mm	MGJT220

2 - Mesa Complemento (Pé Incluso)

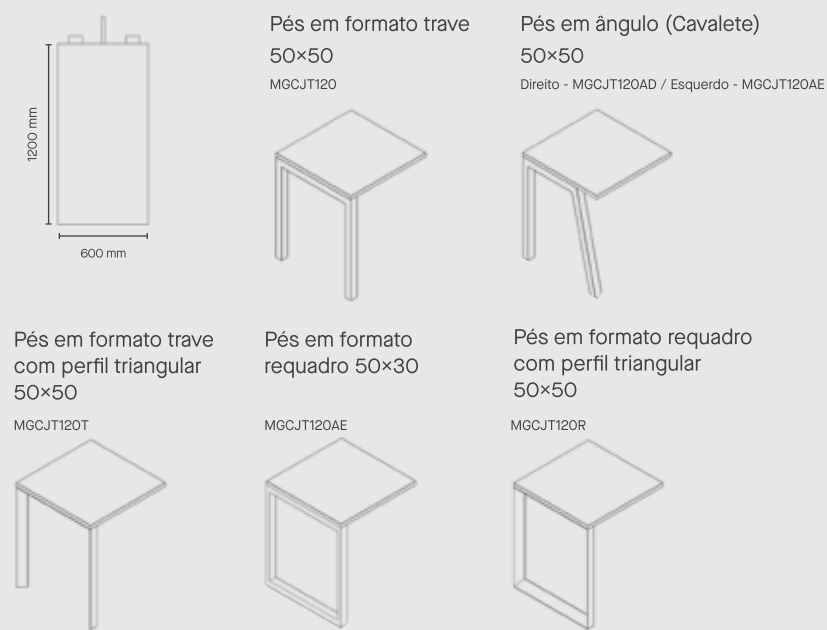

3 - Bases

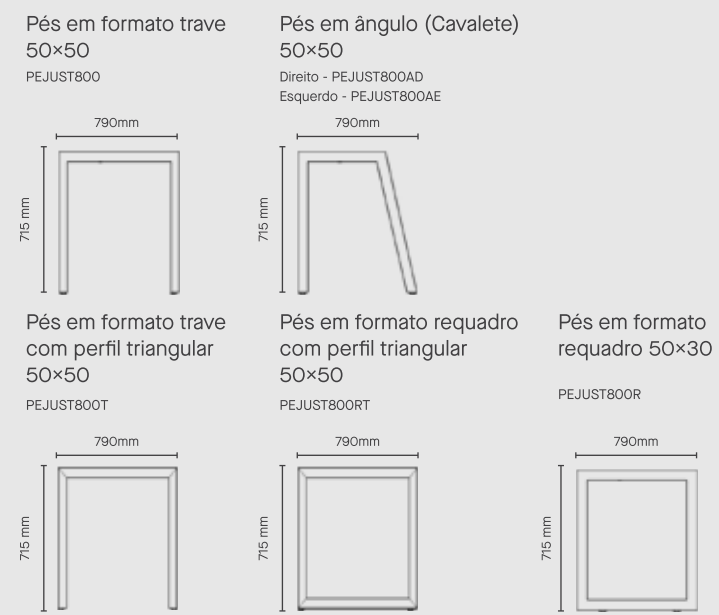

Montagem

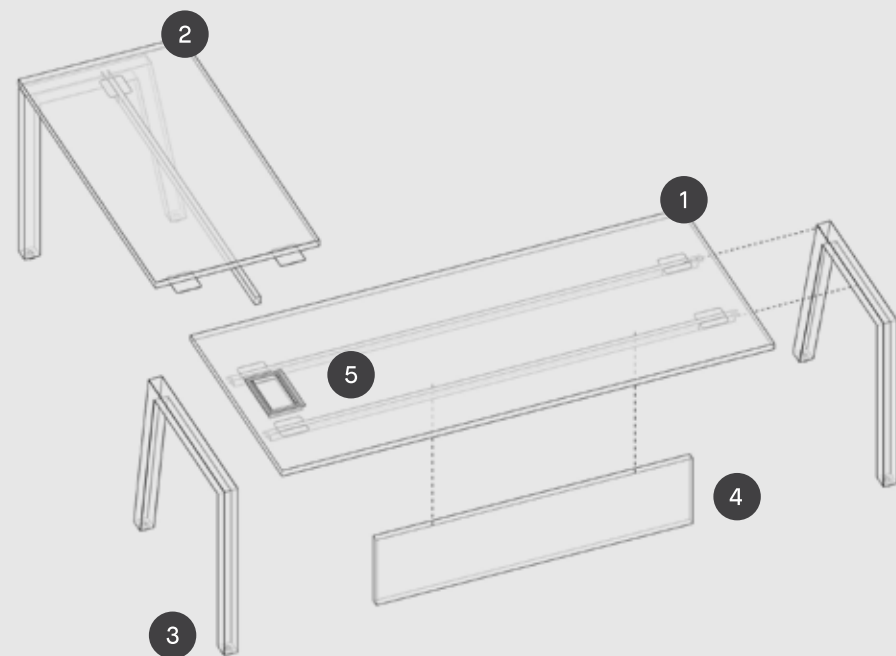

4 - Acessórios

Painel Frontal

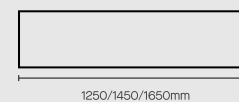

Painel frontal inferior para mesa de gerência .

PNFIT125  
PNFIT145  
PNFIT165

5 - Eletrificação



Conexão completa em cada posto de trabalho: Tomadas posicionadas para melhor acomodação de carregadores e conexão de dados completa. Plugs não inclusos.

1 - Tapos

Tapos Mesa Reta



CÓDIGOS	600mm
1000mm	MRJT1006
1200mm	MRJT1206
1350mm	MRJT13506

2 - Bases

Pés em formato trave 50x50

Direito - JTMR600D  
Esquerdo - JTMR600E

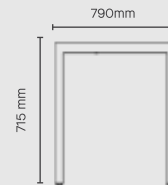

Pés em ângulo (Cavalete) 50x50

Direito - JTMR600AD  
Esquerdo - JTMR600AE

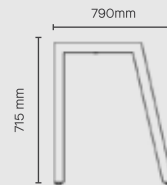

Pés em formato trave com perfil triangular 50x50

Direito - JTMR600TD  
Esquerdo - JTMR600TE

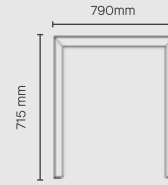

Pés em formato requadro com perfil triangular 50x50

Direito - JTMR600RTD  
Esquerdo - JTMR600RTE

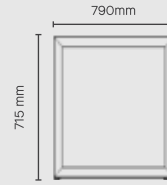

Pés em formato requadro 50x30

Direito - JTMR600RD  
Esquerdo - JTMR600RE

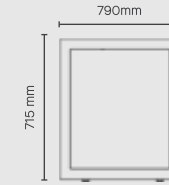

3 - Acessórios

Painel Frontal

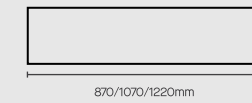

Painel frontal inferior para mesa de gerência .

JTPNF100  
JTPNF120  
JTPNF135

Montagem

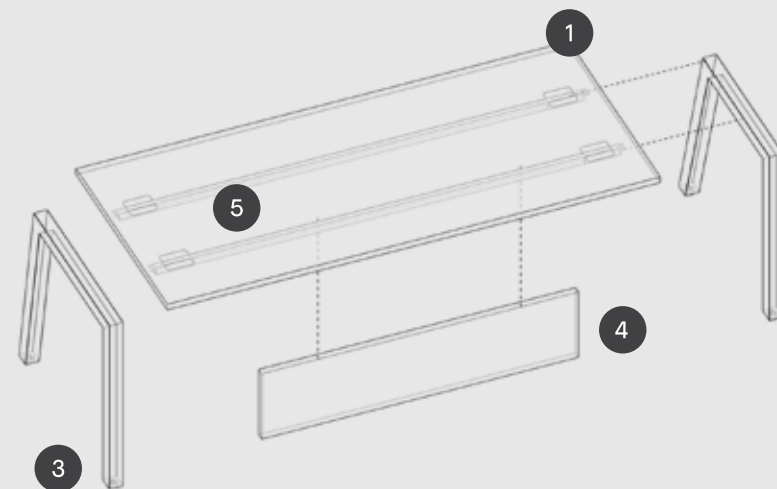



## Gerenciais

Mesas individuais distintivas  
com armário de apoio integrado.



### 1 - Tapos

Tampo Superior



CODIGOS	800mm
1800mm	MAPFT11808
2000mm	MAPFT12008
2200mm	MAPFT12208

### 2 - Armários



CODIGOS	500mm
800mm	Dir - ARMFT0805D Esq - ARMFT0805E
1200mm	Dir - APFT1205GD Esq - APFT1205GE
1600mm	Dir - APFT1605GPD Esq - APFT1605GPE



Armário Nicho

Armário nicho com caixa tomada média (armário de apoio para gerência).

Direito - ARMFT0805D  
Esquerdo - ARMFT0805E

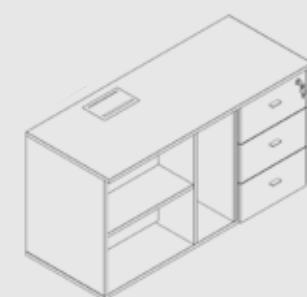

Armário Nicho + Gaveteiro

Armário nicho com caixa de tomada média e gaveteiro com 3 gavetas lado direito (armário de apoio para gerência).

Direito - APFT1205GD  
Esquerdo - APFT1205GE

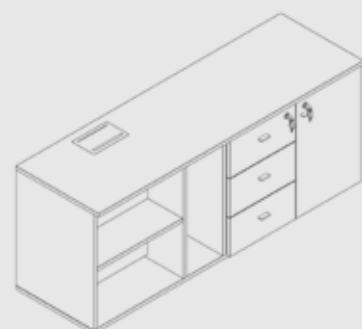

Trave Nicho + Gaveteiro + Porta

Armário nicho com caixa de tomada média, gaveteiro com 3 gavetas e 1 porta lado direito (armário de apoio para gerência).

Direito - APFT1605GPD  
Esquerdo - APFT1605GPE

### 3 - Bases

Pés em formato trave 50x50

PEJUST800

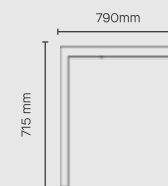

Pés em ângulo (Cavelete) 50x50

Direito - PEJUST800AD  
Esquerdo - PEJUST800AE

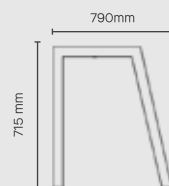

Pés em formato trave com perfil triangular 50x50

PEJUST800T

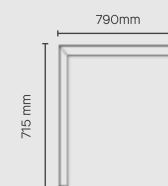

Pés em formato requadro com perfil triangular 50x50

PEJUST800RT

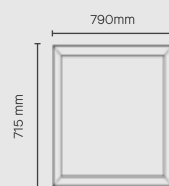

Pés em formato requadro 50x30

PEJUST800R

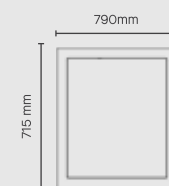

### Montagem

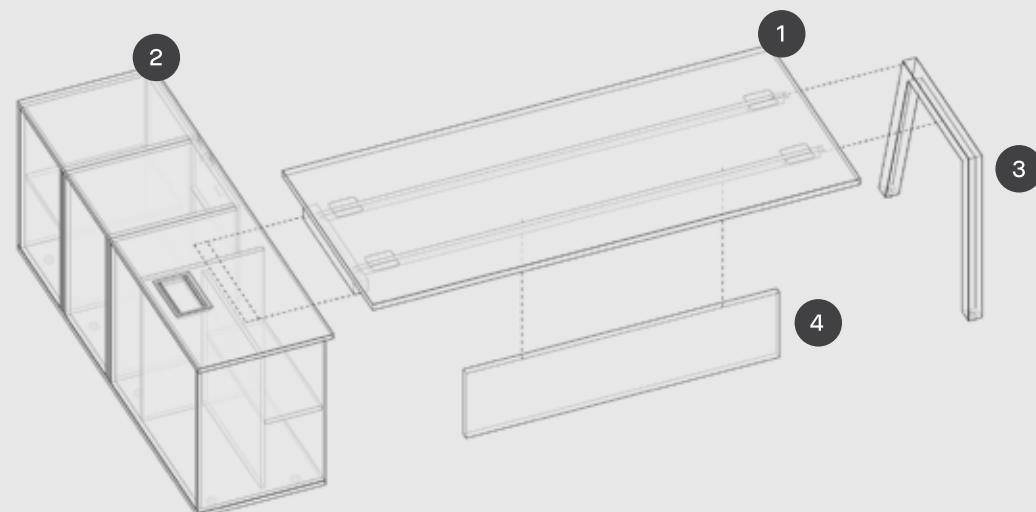

### 4 - Acessórios

Painel Frontal

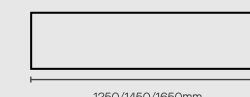

Painel frontal interior para mesa gerência.

PNFIT125  
PNFIT145  
PNFIT165

### 5 - Eletrificação

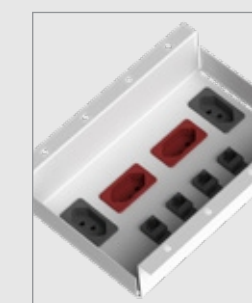

Conexão completa em cada posto de trabalho: Tomadas posicionadas para melhor acomodação de carregadores e conexão de dados completa. Plugs não inclusos.



# Reunião

Planos componíveis para ambientes de reunião de todas as escalas.

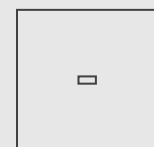

Quadrada



Retangular

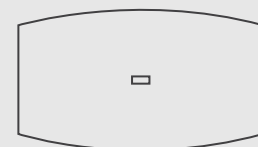

Oval

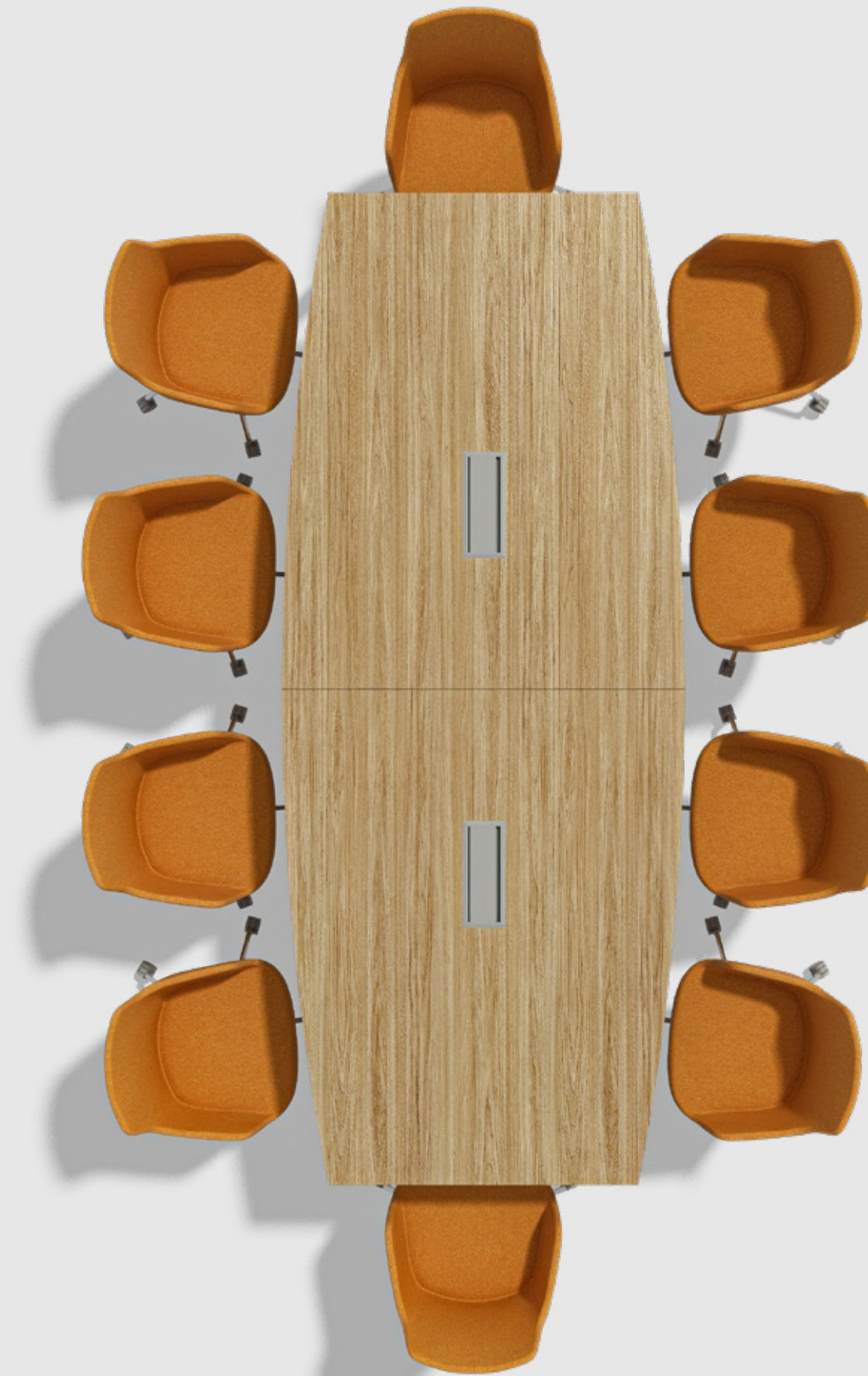

Retangular - Profundidade 1000mm

Sem Pé Central

Tampo de mesa reunião retangular sem pé central.

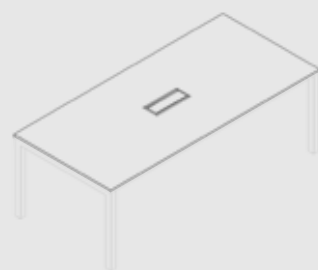

CÓDIGOS	1000mm
1600mm	MREJUST1610
1800mm	MREJUST1810
2000mm	MREJUST2010
2200mm	MREJUST2210

Com Pé Central

Tampo de mesa reunião retangular com pé central.



CÓDIGOS	1000mm
2400mm	MREJUST2410
3200mm	MREJUST3210
3600mm	MREJUST3610
4000mm	MREJUST4010

Semi-Oval - Profundidade 1000mm

Sem Pé Central

Tampo de mesa reunião semi-oval sem pé central.

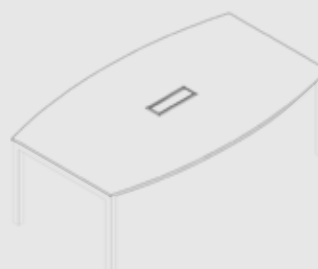

CÓDIGOS	1000mm
1600mm	MREJUST1610S
1800mm	MREJUST1810S
2000mm	MREJUST2010S
2200mm	MREJUST2210S

Com Pé Central

Tampo de mesa reunião semi-oval com pé central.



CÓDIGOS	1000mm
2400mm	MREJUST2410S
3200mm	MREJUST3210S
3600mm	MREJUST3610S
4000mm	MREJUST4010S

Bases

Estrutura lateral em tubo 50 x 50 formato trave.



PEJUST1000

Estrutura lateral em tubo 50 x 50 triangular formato trave.



PEJUST1000T

Quadradas - Profundidade 1600

Com Pé Central

Tampo de mesa reunião retangular com pé central

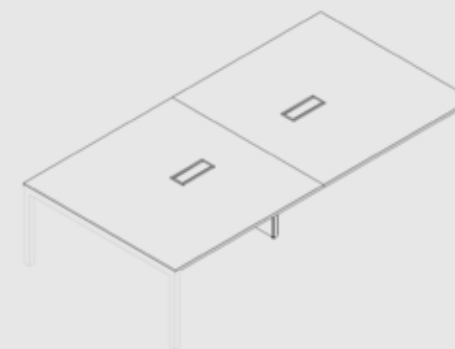

CÓDIGOS	3200mm
1600mm	MREJUST3216

Sem Pé Central

Tampo de mesa reunião quadrado sem pé central

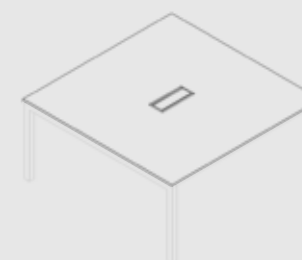

CÓDIGOS	1600mm
1600mm	MREJUST1616



CÓDIGOS	1600mm
1600mm	MREJUST161C

Bases

Estrutura lateral em tubo 50 x 50 formato trave.



PEJUST1600

Estrutura lateral em tubo 50 x 50 triangular formato trave.



PEJUST1600T

Eletrificação

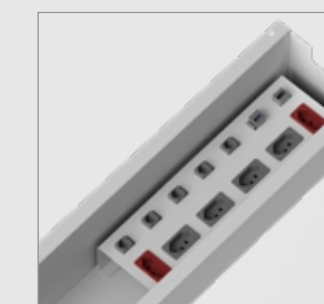

Tomadas posicionadas para melhor acomodação de carregadores e conexão de dados completa. Plugs não inclusos.



## Acabamentos



### MDP/Melaminas

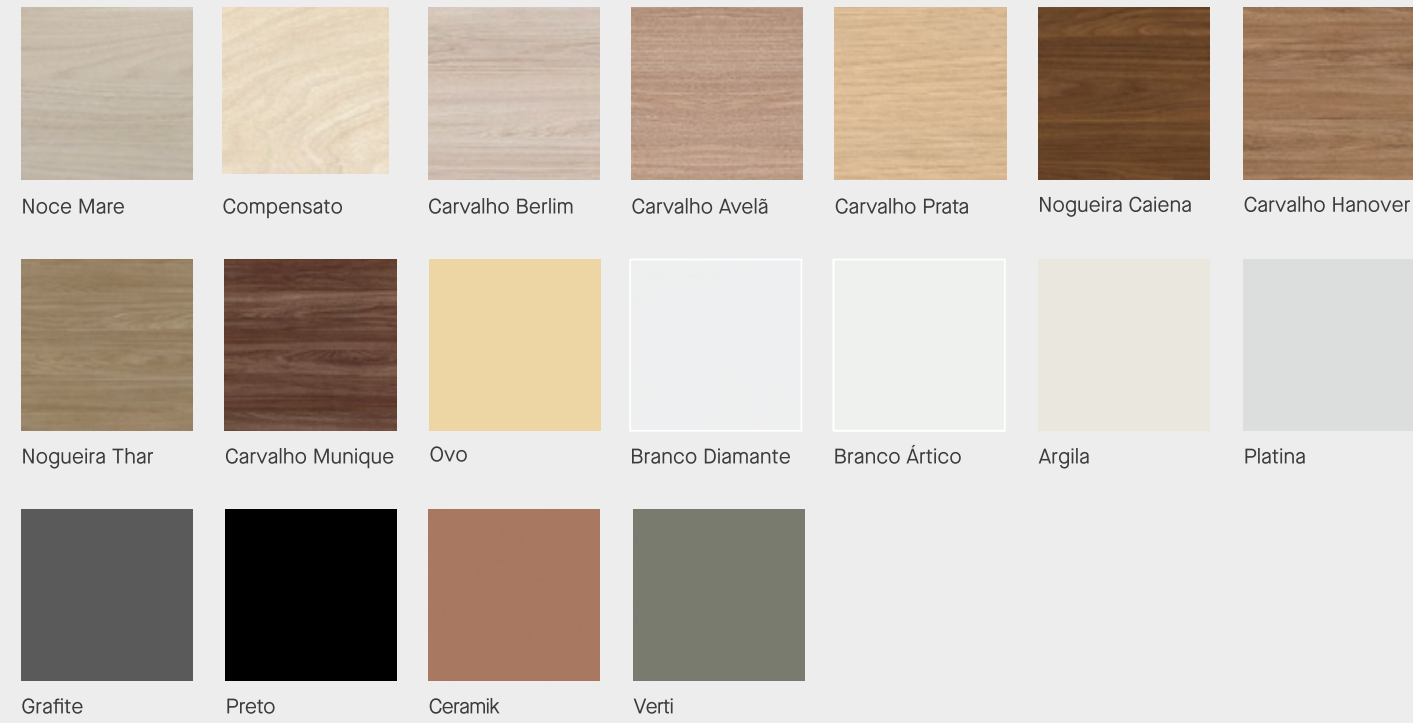

### Acabamentos Metálicos



# Acabamentos



## Tecidos

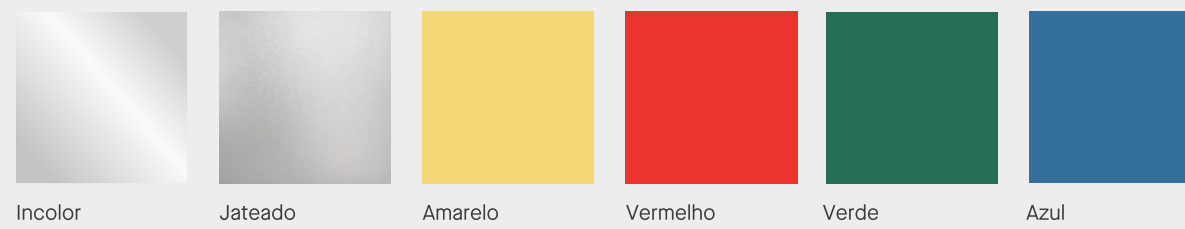

## Laca

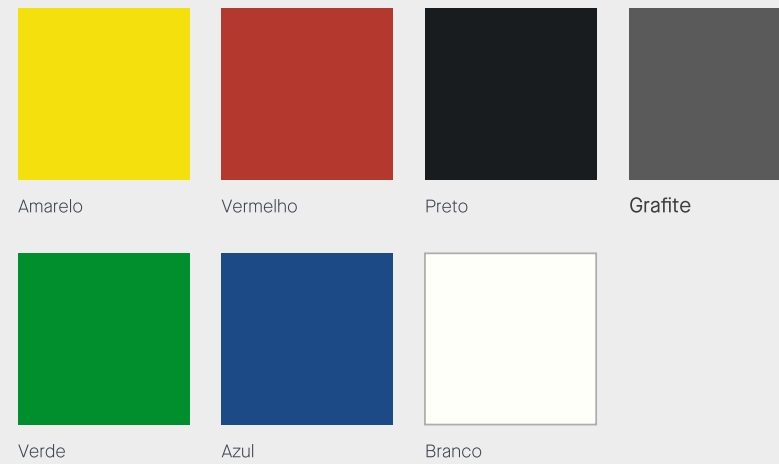

**m**cad  
design & offices